

## HC Series

### Standard Centrifugal Pumps- Close Coupled

PAGE: CP-700

DATE: June 5, 2006

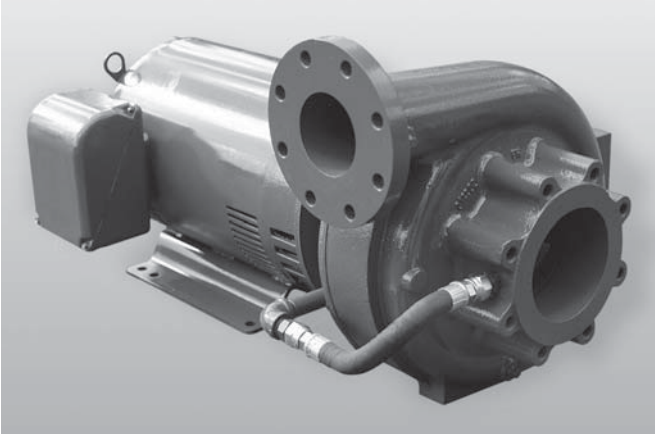

#### Features:

- 1-1/2" - 10" discharge sizes
- Capacities to 7000 GPM, 480' TDH
- Horsepower: Up to 200 HP
- Standard ductile iron construction with bronze wear ring and sleeve
- Replaceable wear rings
- Superior NPSH characteristics
- 150# rated flat faced flanges
- Heavy wall construction
- Grade 5 capscrews
- HC75 & HC10 Series- Enclosed impellers, internally hydraulically balanced
- Double volute on HC10x10-14, for balanced radial forces, HC14 Series- External balance line standard
- Standard with graphite packing or single mechanical seal

#### Model Number Explanation

Example: 7HC31575-CCPHAA

7 = 7.5 Horsepower (CC only)

HC = Horizontal Centrifugal

3 = Suction Size

15 = Discharge Size

75 = Nominal Impeller Dia.

CC = Close Coupled

P = Shaft Sealing:

P=Packing

M=Mechanical Seal

HAA = Impeller Diameter (Alpha)

A=0      F=5      L=10

B=1      G=6      M=11

C=2      H=7      N=12

D=3      J=8      P=13

E=4      K=9      Q=14



**Franklin Electric**

400 East Spring Street, Bluffton, IN 46714

Tel: 260.824.2900 Fax: 260.824.2909

[www.franklinpumps.com](http://www.franklinpumps.com)

## HC Series

### Standard Centrifugal Pumps- Close Coupled

PAGE: CP-705

DATE: June 5, 2006

### Ordering Information

7.5" Nominal Impeller Diameter - (CC) Close Coupled w/Electric Motor								
Standard Construction: Ductile Iron Casing and Impeller, with Bronze Wear Ring(s) and Shaft Sleeve								
Pump Model	Suction/Disch Size	Volute Design	Motor Eff.	HP-RPM	Phase	Shaft Sealing	Order Number	Weight (Lbs.)
HC-3x15-75	3" x 1.5"	Flanged	Std. Eff.	3-3600	1	Packing	50031575110	195
		Flanged	Std. Eff.	5-3600	1	Packing	50031575130	205
		Flanged	Std. Eff.	7.5-3600	1	Packing	50031575140	215
		Flanged	Std. Eff.	10-3600	1	Packing	50031575150	248
HC-3x15-75	3" x 1.5"	Flanged	Std. Eff.	3-3600	3	Packing	10031575110	195
		Flanged	Std. Eff.	5-3600	3	Packing	10031575130	205
		Flanged	Std. Eff.	7.5-3600	3	Packing	10031575140	215
		Flanged	Std. Eff.	10-3600	3	Packing	10031575150	248
HC-3x15-75	3" x 1.5"	Flanged	Std. Eff.	3-3600	1	Mech Seal	51031575111	195
		Flanged	Std. Eff.	5-3600	1	Mech Seal	51031575131	205
		Flanged	Std. Eff.	7.5-3600	1	Mech Seal	51031575141	215
		Flanged	Std. Eff.	10-3600	1	Mech Seal	51031575151	248
HC-3x15-75	3" x 1.5"	Flanged	Std. Eff.	3-3600	3	Mech Seal	11031575111	195
		Flanged	Std. Eff.	5-3600	3	Mech Seal	11031575131	205
		Flanged	Std. Eff.	7.5-3600	3	Mech Seal	11031575141	215
		Flanged	Std. Eff.	10-3600	3	Mech Seal	11031575151	248
HC-3x2-75	3" x 2"	Flanged	Std. Eff.	3-3600	1	Packing	50030275100	190
		Flanged	Std. Eff.	5-3600	1	Packing	50030275110	200
		Flanged	Std. Eff.	7.5-3600	1	Packing	50030275130	210
		Flanged	Std. Eff.	10-3600	1	Packing	50030275140	243
HC-3x2-75	3" x 2"	Flanged	Std. Eff.	3-3600	3	Packing	10030275100	190
		Flanged	Std. Eff.	5-3600	3	Packing	10030275110	200
		Flanged	Std. Eff.	7.5-3600	3	Packing	10030275130	210
		Flanged	Std. Eff.	10-3600	3	Packing	10030275140	243
		Flanged	Std. Eff.	15-3600	3	Packing	10030275150	257
HC-3x2-75	3" x 2"	Flanged	Std. Eff.	3-3600	1	Mech Seal	51030275101	190
		Flanged	Std. Eff.	5-3600	1	Mech Seal	51030275111	200
		Flanged	Std. Eff.	7.5-3600	1	Mech Seal	51030275131	210
		Flanged	Std. Eff.	10-3600	1	Mech Seal	51030275141	243
HC-3x2-75	3" x 2"	Flanged	Std. Eff.	3-3600	3	Mech Seal	11030275101	190
		Flanged	Std. Eff.	5-3600	3	Mech Seal	11030275111	200
		Flanged	Std. Eff.	7.5-3600	3	Mech Seal	11030275131	210
		Flanged	Std. Eff.	10-3600	3	Mech Seal	11030275141	243
		Flanged	Std. Eff.	15-3600	3	Mech Seal	11030275151	257
HC-4x25-75	4" x 2.5"	Flanged	Std. Eff.	7.5-3600	1	Packing	50042575100	225
		Flanged	Std. Eff.	10-3600	1	Packing	50042575110	258
HC-4x25-75	4" x 2.5"	Flanged	Std. Eff.	7.5-3600	3	Packing	10042575100	225
		Flanged	Std. Eff.	10-3600	3	Packing	10042575110	258
		Flanged	Std. Eff.	15-3600	3	Packing	10042575130	272
		Flanged	Std. Eff.	20-3600	3	Packing	10042575140	292
		Flanged	Std. Eff.	25-3600	3	Packing	10042575150	302
HC-4x25-75	4" x 2.5"	Flanged	Std. Eff.	7.5-3600	1	Mech Seal	51042575101	225
		Flanged	Std. Eff.	10-3600	1	Mech Seal	51042575111	258
HC-4x25-75	4" x 2.5"	Flanged	Std. Eff.	7.5-3600	3	Mech Seal	11042575101	225
		Flanged	Std. Eff.	10-3600	3	Mech Seal	11042575111	258
		Flanged	Std. Eff.	15-3600	3	Mech Seal	11042575131	272
		Flanged	Std. Eff.	20-3600	3	Mech Seal	11042575141	292
		Flanged	Std. Eff.	25-3600	3	Mech Seal	11042575151	302

NOTES: Viton Seals available. Consult price sheets for list price adders.  
 There will be an impeller trimming charge applied for any non-standard impeller trim.  
 Consult price sheets for list price adders.



## HC Series

### Standard Centrifugal Pumps- Close Coupled

#### Ordering Information Cont.

7.5" Nominal Impeller Diameter - (CC) Close Coupled w/Electric Motor								
Standard Construction: Ductile Iron Casing and Impeller, with Bronze Wear Ring(s) and Shaft Sleeve								
Pump Model	Suction/Disch Size	Volute Design	Motor Eff.	HP-RPM	Phase	Shaft Sealing	Order Number	Weight (Lbs.)
HC-4x3-75	4" x 3"	Flanged	Std. Eff.	7.5-3600	1	Packing	50040375100	235
		Flanged	Std. Eff.	10-3600	1	Packing	50040375110	268
HC-4x3-75	4" x 3"	Flanged	Std. Eff.	7.5-3600	3	Packing	10040375100	235
		Flanged	Std. Eff.	10-3600	3	Packing	10040375110	268
		Flanged	Std. Eff.	15-3600	3	Packing	10040375120	282
		Flanged	Std. Eff.	20-3600	3	Packing	10040375130	302
		Flanged	Std. Eff.	25-3600	3	Packing	10040375140	312
		Flanged	Std. Eff.	30-3600	3	Packing	10040375150	464
HC-4x3-75	4" x 3"	Flanged	Std. Eff.	7.5-3600	1	Mech Seal	51040375101	235
		Flanged	Std. Eff.	10-3600	1	Mech Seal	51040375111	268
HC-4x3-75	4" x 3"	Flanged	Std. Eff.	7.5-3600	3	Mech Seal	11040375101	235
		Flanged	Std. Eff.	10-3600	3	Mech Seal	11040375111	268
		Flanged	Std. Eff.	15-3600	3	Mech Seal	11040375121	282
		Flanged	Std. Eff.	20-3600	3	Mech Seal	11040375131	302
		Flanged	Std. Eff.	25-3600	3	Mech Seal	11040375141	312
		Flanged	Std. Eff.	30-3600	3	Mech Seal	11040375151	464
HC-4x4-75	4" x 4"	Flanged	Std. Eff.	15-3600	3	Packing	10040475100	282
		Flanged	Std. Eff.	20-3600	3	Packing	10040475110	302
		Flanged	Std. Eff.	25-3600	3	Packing	10040475120	312
		Flanged	Std. Eff.	30-3600	3	Packing	10040475130	464
		Flanged	Std. Eff.	40-3600	3	Packing	10040475140	502
		Flanged	Std. Eff.	50-3600	3	Packing	10040475150	546
HC-4x4-75	4" x 4"	Flanged	Std. Eff.	15-3600	3	Mech Seal	11040475101	282
		Flanged	Std. Eff.	20-3600	3	Mech Seal	11040475111	302
		Flanged	Std. Eff.	25-3600	3	Mech Seal	11040475121	312
		Flanged	Std. Eff.	30-3600	3	Mech Seal	11040475131	464
		Flanged	Std. Eff.	40-3600	3	Mech Seal	11040475141	502
		Flanged	Std. Eff.	50-3600	3	Mech Seal	11040475151	546
HC-5x4-75	5" x 4"	Flanged	Std. Eff.	25-3600	3	Packing	10050475100	449
		Flanged	Std. Eff.	30-3600	3	Packing	10050475105	484
		Flanged	Std. Eff.	40-3600	3	Packing	10050475110	522
		Flanged	Std. Eff.	50-3600	3	Packing	10050475120	566
		Flanged	Std. Eff.	60-3600	3	Packing	10050475130	569
HC-5x4-75	5" x 4"	Flanged	Std. Eff.	25-3600	3	Mech Seal	11050475101	449
		Flanged	Std. Eff.	30-3600	3	Mech Seal	11050475106	484
		Flanged	Std. Eff.	40-3600	3	Mech Seal	11050475111	522
		Flanged	Std. Eff.	50-3600	3	Mech Seal	11050475121	566
		Flanged	Std. Eff.	60-3600	3	Mech Seal	11050475131	569

**NOTES:** Viton Seals available. Consult price sheets for list price adders.  
 There will be an impeller trimming charge applied for any non-standard impeller trim.  
 Consult price sheets for list price adders.



**Franklin Electric**

400 East Spring Street, Bluffton, IN 46714  
 Tel: 260.824.2900 Fax: 260.824.2909  
[www.franklinpumps.com](http://www.franklinpumps.com)

## HC Series

### Standard Centrifugal Pumps- Close Coupled

PAGE: CP-710

DATE: June 5, 2006

#### Ordering Information Cont.

10" Nominal Impeller Diameter - (CC) Close Coupled w/Electric Motor								
Standard Construction: Ductile Iron Casing and Impeller, with Bronze Wear Ring(s) and Shaft Sleeve								
Pump Model	Suction/Disch Size	Volute Design	Motor Eff.	HP-RPM	Phase	Shaft Sealing	Order Number	Weight (Lbs.)
HC-3x2-10	3" x 2"	Flanged	Std. Eff.	10-3600	3	Packing	10030210100	315
		Flanged	Std. Eff.	15-3600	3	Packing	10030210110	327
		Flanged	Std. Eff.	20-3600	3	Packing	10030210115	322
		Flanged	Std. Eff.	25-3600	3	Packing	10030210120	337
		Flanged	Std. Eff.	30-3600	3	Packing	10030210130	484
HC-3x2-10	3" x 2"	Flanged	Std. Eff.	10-3600	1	Packing	50030210100	315
		Flanged	Std. Eff.	10-3600	3	Mech Seal	11030210101	315
		Flanged	Std. Eff.	15-3600	3	Mech Seal	11030210111	327
		Flanged	Std. Eff.	20-3600	3	Mech Seal	11030210116	322
		Flanged	Std. Eff.	25-3600	3	Mech Seal	11030210121	337
HC-4x25-10	4" x 2.5"	Flanged	Std. Eff.	30-3600	3	Mech Seal	11030210131	484
		Flanged	Std. Eff.	10-1800	1	Mech Seal	51030210101	315
		Flanged	Std. Eff.	15-3600	3	Packing	10042510100	354
		Flanged	Std. Eff.	20-3600	3	Packing	10042510105	327
		Flanged	Std. Eff.	25-3600	3	Packing	10042510110	347
		Flanged	Std. Eff.	30-3600	3	Packing	10042510115	494
		Flanged	Std. Eff.	40-3600	3	Packing	10042510120	532
		Flanged	Std. Eff.	50-3600	3	Packing	10042510125	576
		Flanged	Std. Eff.	60-3600	3	Packing	10042510130	579
		Flanged	Std. Eff.	2-1800	3	Packing	20042510100	230
HC-4x25-10	4" x 2.5"	Flanged	Std. Eff.	3-1800	3	Packing	20042510110	249
		Flanged	Std. Eff.	5-1800	3	Packing	20042510120	265
		Flanged	Std. Eff.	7.5-1800	3	Packing	20042510130	278
		Flanged	Std. Eff.	5-1800	1	Packing	50042510120	265
		Flanged	Std. Eff.	7.5-1800	1	Packing	50042510130	278
HC-4x25-10	4" x 2.5"	Flanged	Std. Eff.	15-3600	3	Mech Seal	11042510101	354
		Flanged	Std. Eff.	20-3600	3	Mech Seal	11042510106	327
		Flanged	Std. Eff.	25-3600	3	Mech Seal	11042510111	347
		Flanged	Std. Eff.	30-3600	3	Mech Seal	11042510116	494
		Flanged	Std. Eff.	40-3600	3	Mech Seal	11042510121	532
		Flanged	Std. Eff.	50-3600	3	Mech Seal	11042510126	576
		Flanged	Std. Eff.	60-3600	3	Mech Seal	11042510131	579
		Flanged	Std. Eff.	2-1800	3	Mech Seal	21042510101	230
		Flanged	Std. Eff.	3-1800	3	Mech Seal	21042510111	249
		Flanged	Std. Eff.	5-1800	3	Mech Seal	21042510121	265
HC-4x25-10	4" x 2.5"	Flanged	Std. Eff.	7.5-1800	3	Mech Seal	21042510131	278
		Flanged	Std. Eff.	5-1800	1	Mech Seal	51042510121	265
HC-4x25-10	4" x 2.5"	Flanged	Std. Eff.	7.5-1800	1	Mech Seal	51042510131	278
		Flanged	Std. Eff.	30-3600	3	Packing	10040310100	489
HC-4x3-10	4" x 3"	Flanged	Std. Eff.	40-3600	3	Packing	10040310110	527
		Flanged	Std. Eff.	50-3600	3	Packing	10040310120	571
		Flanged	Std. Eff.	60-3600	3	Packing	10040310125	574
		Flanged	e-pact eff.	75-3600	3	Packing	10040310130	662
		Flanged	e-pact eff.	100-3600	3	Packing	10040310140	708
HC-4x3-10	4" x 3"	Flanged	Std. Eff.	30-3600	3	Mech Seal	11040310101	489
		Flanged	Std. Eff.	40-3600	3	Mech Seal	11040310111	527
		Flanged	Std. Eff.	50-3600	3	Mech Seal	11040310121	571
		Flanged	Std. Eff.	60-3600	3	Mech Seal	11040310126	574
		Flanged	e-pact eff.	75-3600	3	Mech Seal	11040310131	662
		Flanged	e-pact eff.	100-3600	3	Mech Seal	11040310141	708

NOTES: Viton Seals available. Consult price sheets for list price adders.  
 There will be an impeller trimming charge applied for any non-standard impeller trim.  
 Consult price sheets for list price adders.



## HC Series

### Standard Centrifugal Pumps- Close Coupled

#### Ordering Information Cont.

10" Nominal Impeller Diameter - (CC) Close Coupled w/Electric Motor								
Standard Construction: Ductile Iron Casing and Impeller, with Bronze Wear Ring(s) and Shaft Sleeve								
Pump Model	Suction/Disch Size	Volute Design	Motor Eff.	HP-RPM	Phase	Shaft Sealing	Order Number	Weight (Lbs.)
HC-6x4-10	6" x 4"	Flanged	Std. Eff.	30-3600	3	Packing	10060410100	552
		Flanged	Std. Eff.	40-3600	3	Packing	10060410105	592
		Flanged	Std. Eff.	50-3600	3	Packing	10060410110	636
		Flanged	Std. Eff.	60-3600	3	Packing	10060410115	639
		Flanged	e-pact eff.	75-3600	3	Packing	10060410120	727
		Flanged	e-pact eff.	100-3600	3	Packing	10060410130	773
HC-6x4-10	6" x 4"	Flanged	e-pact eff.	125-3600	3	Packing	10060410140	848
		Flanged	Std. Eff.	30-3600	3	Mech Seal	11060410101	552
		Flanged	Std. Eff.	40-3600	3	Mech Seal	11060410106	592
		Flanged	Std. Eff.	50-3600	3	Mech Seal	11060410111	636
		Flanged	Std. Eff.	60-3600	3	Mech Seal	11060410116	639
		Flanged	e-pact eff.	75-3600	3	Mech Seal	11060410121	727
HC-6x4-10	6" x 4"	Flanged	e-pact eff.	100-3600	3	Mech Seal	11060410131	773
		Flanged	e-pact eff.	125-3600	3	Mech Seal	10060410141	848
		Flanged	Std. Eff.	15-1800	3	Packing	20080695100	544
		Flanged	Std. Eff.	20-1800	3	Packing	20080695110	577
		Flanged	Std. Eff.	25-1800	3	Packing	20080695120	625
		Flanged	e-pact eff.	5-1200	3	Packing	30080695100	455
HC-8x6-95	8" x 6"	Flanged	e-pact eff.	7.5-1200	3	Packing	30080695110	468
		Flanged	Std. Eff.	15-1800	3	Mech Seal	21080695101	544
		Flanged	Std. Eff.	20-1800	3	Mech Seal	21080695111	577
		Flanged	Std. Eff.	25-1800	3	Mech Seal	21080695121	625
		Flanged	e-pact eff.	5-1200	3	Mech Seal	31080695101	455
		Flanged	e-pact eff.	7.5-1200	3	Mech Seal	31080695111	468
HC-8x6-95	8" x 6"	Flanged	Std. Eff.	20-1800	3	Mech Seal	20080610100	582
		Flanged	Std. Eff.	30-1800	3	Packing	20080610110	672
		Flanged	Std. Eff.	40-1800	3	Packing	20080610120	777
		Flanged	e-pact eff.	5-1200	3	Packing	30080610100	500
		Flanged	e-pact eff.	7.5-1200	3	Packing	30080610110	535
		Flanged	e-pact eff.	10-1200	3	Packing	30080610120	600
HC-8x6-10	8" x 6"	Flanged	Std. Eff.	20-1800	3	Mech Seal	21080610101	582
		Flanged	Std. Eff.	30-1800	3	Mech Seal	21080610111	672
		Flanged	Std. Eff.	40-1800	3	Mech Seal	21080610121	777
		Flanged	e-pact eff.	5-1200	3	Mech Seal	31080610101	500
		Flanged	e-pact eff.	7.5-1200	3	Mech Seal	31080610111	535
		Flanged	e-pact eff.	10-1200	3	Mech Seal	31080610121	600

**NOTES:** Viton Seals available. Consult price sheets for list price adders.  
 There will be an impeller trimming charge applied for any non-standard impeller trim.  
 Consult price sheets for list price adders.



**Franklin Electric**

400 East Spring Street, Bluffton, IN 46714  
 Tel: 260.824.2900 Fax: 260.824.2909  
[www.franklinpumps.com](http://www.franklinpumps.com)

## HC Series

### Standard Centrifugal Pumps- Close Coupled

PAGE: CP-715

DATE: June 5, 2006

#### Ordering Information Cont.

14" Nominal Impeller Diameter - (CC) Close Coupled w/Electric Motor								
Standard Construction: Ductile Iron Casing and Impeller, with Bronze Wear Ring(s) and Shaft Sleeve								
Pump Model	Suction/Disch Size	Volute Design	Motor Eff.	HP-RPM	Phase	Shaft Sealing	Order Number	Weight (Lbs.)
HC-5x3-14	5" x 3"	Flanged	Std. Eff.	20-1800	3	Packing	20050314100	572
		Flanged	Std. Eff.	25-1800	3	Packing	20050314110	600
		Flanged	Std. Eff.	30-1800	3	Packing	20050314120	642
		Flanged	Std. Eff.	40-1800	3	Packing	20050314130	747
HC-5x3-14	5" x 3"	Flanged	Std. Eff.	20-1800	3	Mech Seal	21050314101	572
		Flanged	Std. Eff.	25-1800	3	Mech Seal	21050314111	600
		Flanged	Std. Eff.	30-1800	3	Mech Seal	21050314121	642
		Flanged	Std. Eff.	40-1800	3	Mech Seal	21050314131	747
HC-6x4-13	6" x 4"	Flanged	Std. Eff.	30-1800	3	Packing	20060413100	647
		Flanged	Std. Eff.	40-1800	3	Packing	20060413110	752
		Flanged	Std. Eff.	50-1800	3	Packing	20060413120	807
		Flanged	Std. Eff.	60-1800	3	Packing	20060413130	838
HC-6x4-13	6" x 4"	Flanged	Std. Eff.	30-1800	3	Mech Seal	21060413101	647
		Flanged	Std. Eff.	40-1800	3	Mech Seal	21060413111	752
		Flanged	Std. Eff.	50-1800	3	Mech Seal	21060413121	807
		Flanged	Std. Eff.	60-1800	3	Mech Seal	21060413131	838
HC-6x6-14	6" x 6"	Flanged	e-pact eff.	40-1800	3	Packing	20060414100	842
		Flanged	e-pact eff.	50-1800	3	Packing	20060414110	897
		Flanged	e-pact eff.	60-1800	3	Packing	20060414120	928
		Flanged	e-pact eff.	75-1800	3	Packing	20060414130	1005
HC-6x6-14	6" x 6"	Flanged	e-pact eff.	100-1800	3	Packing	20060414140	1247
		Flanged	e-pact eff.	40-1800	3	Mech Seal	21060414101	842
		Flanged	e-pact eff.	50-1800	3	Mech Seal	21060414111	897
		Flanged	e-pact eff.	60-1800	3	Mech Seal	21060414121	928
HC-6x6-14	6" x 6"	Flanged	e-pact eff.	75-1800	3	Mech Seal	20060414131	1005
		Flanged	e-pact eff.	100-1800	3	Mech Seal	21060414141	1247
		Flanged	e-pact eff.	75-1800	3	Packing	20080614100	1110
		Flanged	e-pact eff.	100-1800	3	Packing	20080614110	1352
HC-8x6-14	8" x 6"	Flanged	e-pact eff.	125-1800	3	Packing	20080614120	1492
		Flanged	e-pact eff.	150-1800	3	Packing	20080614130	2038
		Flanged	e-pact eff.	20-1200	3	Packing	30080614100	915
		Flanged	e-pact eff.	25-1200	3	Packing	30080614110	955
HC-8x6-14	8" x 6"	Flanged	e-pact eff.	30-1200	3	Packing	30080614120	985
		Flanged	e-pact eff.	40-1200	3	Packing	30060814130	1125
		Flanged	e-pact eff.	75-1800	3	Mech Seal	21080614101	1110
		Flanged	e-pact eff.	100-1800	3	Mech Seal	21080614111	1352
HC-8x6-14	8" x 6"	Flanged	e-pact eff.	125-1800	3	Mech Seal	21080614121	1492
		Flanged	e-pact eff.	150-1800	3	Mech Seal	21080614131	2038
		Flanged	e-pact eff.	20-1200	3	Mech Seal	31080614101	915
		Flanged	e-pact eff.	25-1200	3	Mech Seal	31080614111	955
HC-8x6-14	8" x 6"	Flanged	e-pact eff.	30-1200	3	Mech Seal	31080614121	985
		Flanged	e-pact eff.	40-1200	3	Mech Seal	31080614131	1125

**NOTES:** Viton Seals available. Consult price sheets for list price adders.  
 There will be an impeller trimming charge applied for any non-standard impeller trim.  
 Consult price sheets for list price adders.



## HC Series

### Standard Centrifugal Pumps- Close Coupled

#### Ordering Information Cont.

14" Nominal Impeller Diameter - (CC) Close Coupled w/Electric Motor								
Standard Construction: Ductile Iron Casing and Impeller, with Bronze Wear Ring(s) and Shaft Sleeve								
Pump Model	Suction/Disch Size	Volute Design	Motor Eff.	HP-RPM	Phase	Shaft Sealing	Order Number	Weight (Lbs.)
HC-10x10-14	10" x 10"	Flanged	e-pact eff.	100-1800	3	Packing	20101014100	1597
		Flanged	e-pact eff.	125-1800	3	Packing	20101014110	1737
		Flanged	e-pact eff.	150-1800	3	Packing	20101014120	2298
		Flanged	e-pact eff.	200-1800	3	Packing	20101014130	2365
		Flanged	e-pact eff.	25-1200	3	Packing	30101014100	1330
		Flanged	e-pact eff.	40-1200	3	Packing	30101014110	1370
		Flanged	e-pact eff.	50-1200	3	Packing	30101014120	1410
		Flanged	e-pact eff.	60-1200	3	Packing	30101014130	1630
HC-10x10-14	10" x 10"	Flanged	e-pact eff.	100-1800	3	Mech Seal	21101014101	1597
		Flanged	e-pact eff.	125-1800	3	Mech Seal	21101014111	1737
		Flanged	e-pact eff.	150-1800	3	Mech Seal	21101014121	2298
		Flanged	e-pact eff.	200-1800	3	Mech Seal	21101014131	2365
		Flanged	e-pact eff.	25-1200	3	Mech Seal	31101014101	1330
		Flanged	e-pact eff.	40-1200	3	Mech Seal	31101014111	1370
		Flanged	e-pact eff.	50-1200	3	Mech Seal	31101014121	1410
		Flanged	e-pact eff.	60-1200	3	Mech Seal	31101014131	1630

**NOTES:** Viton Seals available. Consult price sheets for list price adders.  
 There will be an impeller trimming charge applied for any non-standard impeller trim.  
 Consult price sheets for list price adders.



**Franklin Electric**

400 East Spring Street, Bluffton, IN 46714  
 Tel: 260.824.2900 Fax: 260.824.2909  
[www.franklinpumps.com](http://www.franklinpumps.com)

## HC Series

### Standard Centrifugal Pumps- Close Coupled

PAGE: CP-720

DATE: June 5, 2006

#### Model HC-3x15-75

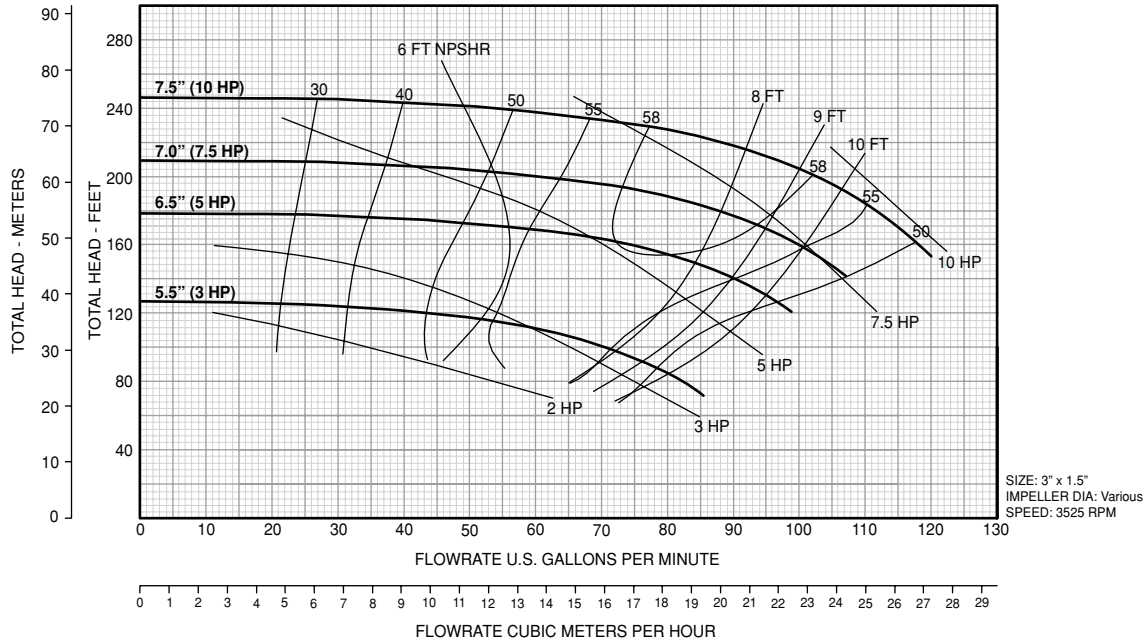

#### Model HC-3x2-75

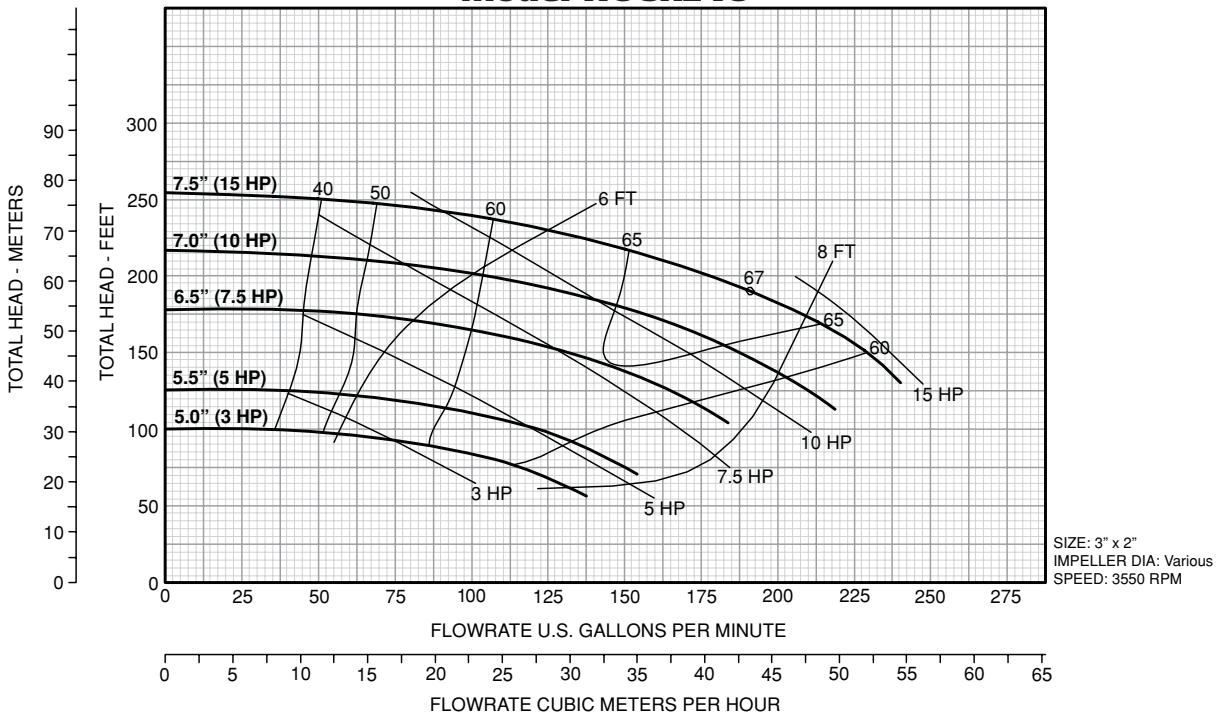

## HC Series

### Standard Centrifugal Pumps- Close Coupled

#### Model HC-4x25-75

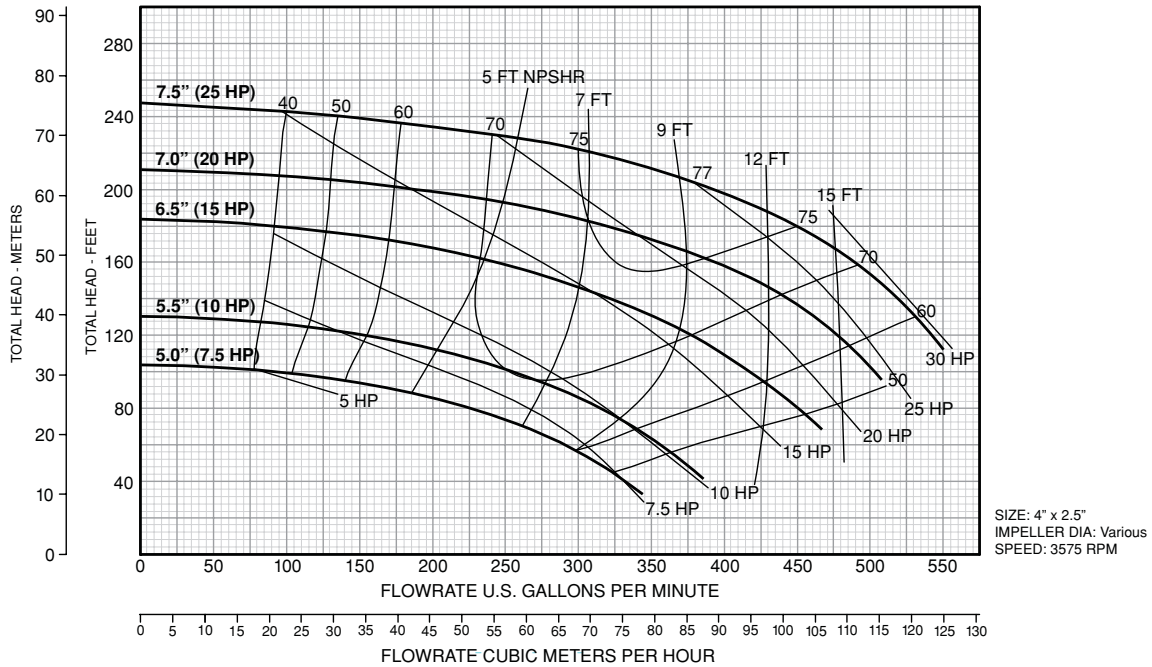

#### Model HC-4x3-75

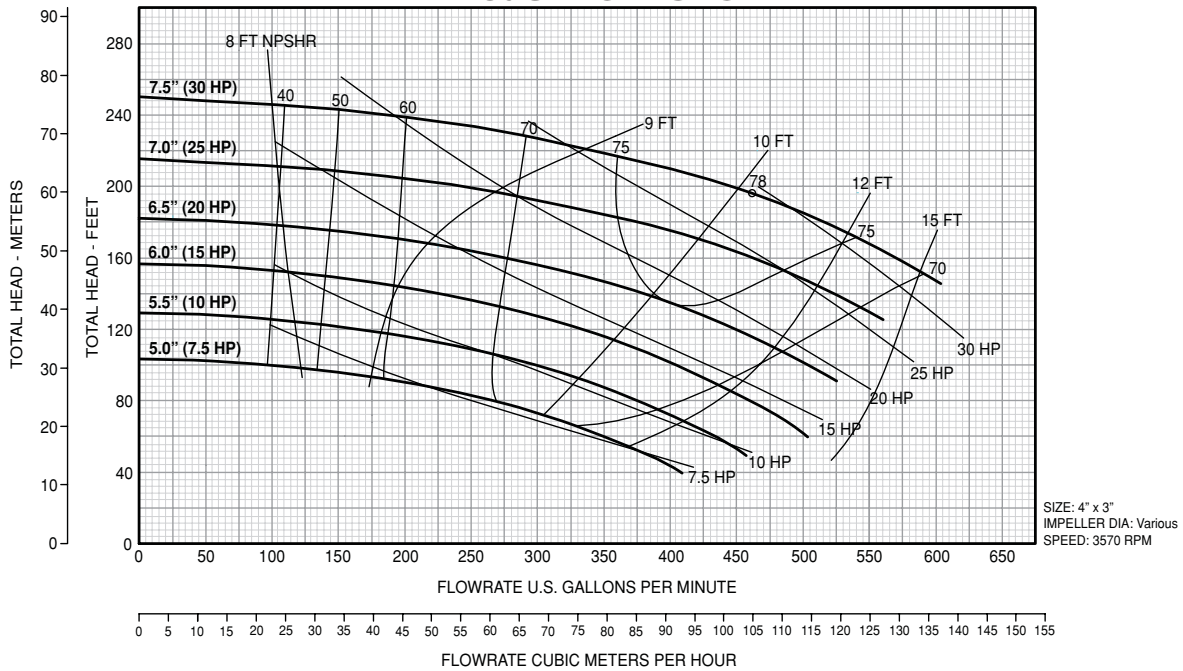

## HC Series

### Standard Centrifugal Pumps- Close Coupled

PAGE: CP-725

DATE: June 5, 2006

#### Model HC-4x4-75

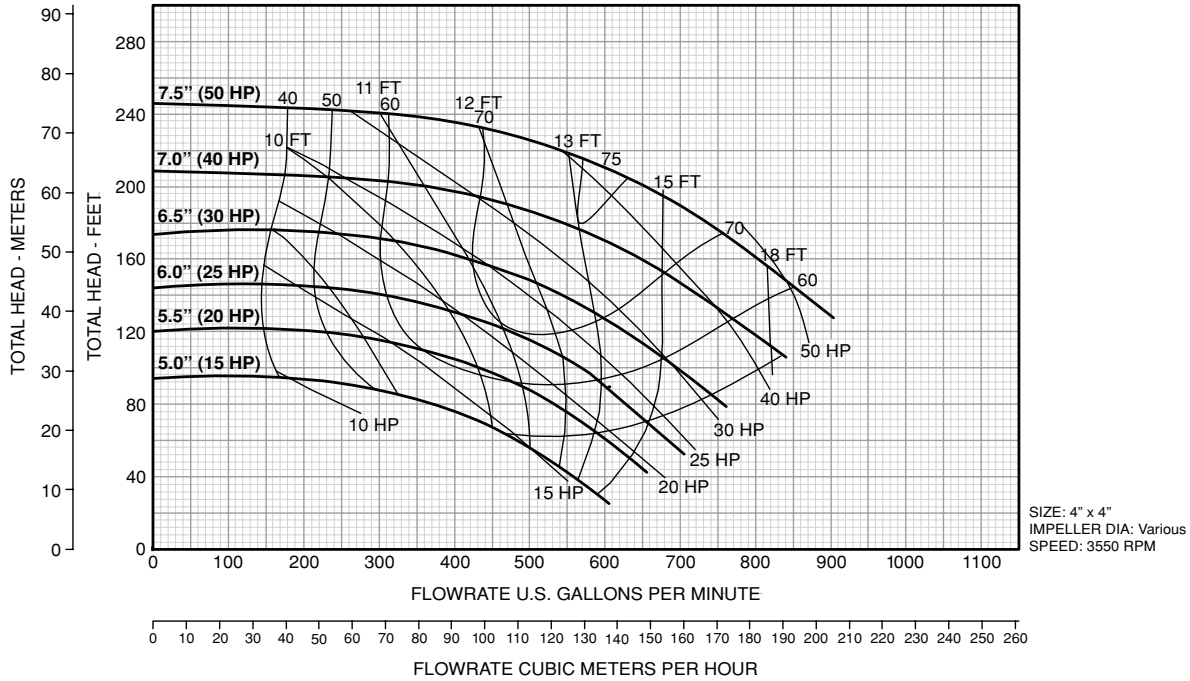

#### Model HC-5x4-75

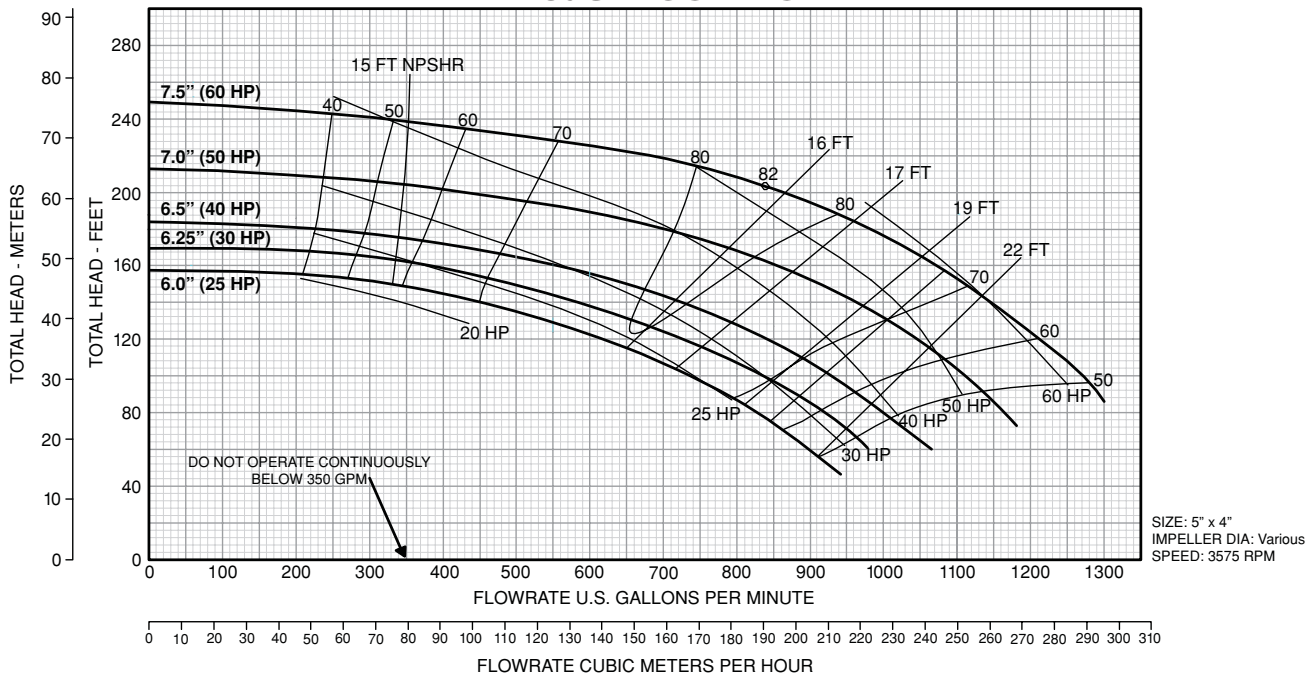

## HC Series

### Standard Centrifugal Pumps- Close Coupled

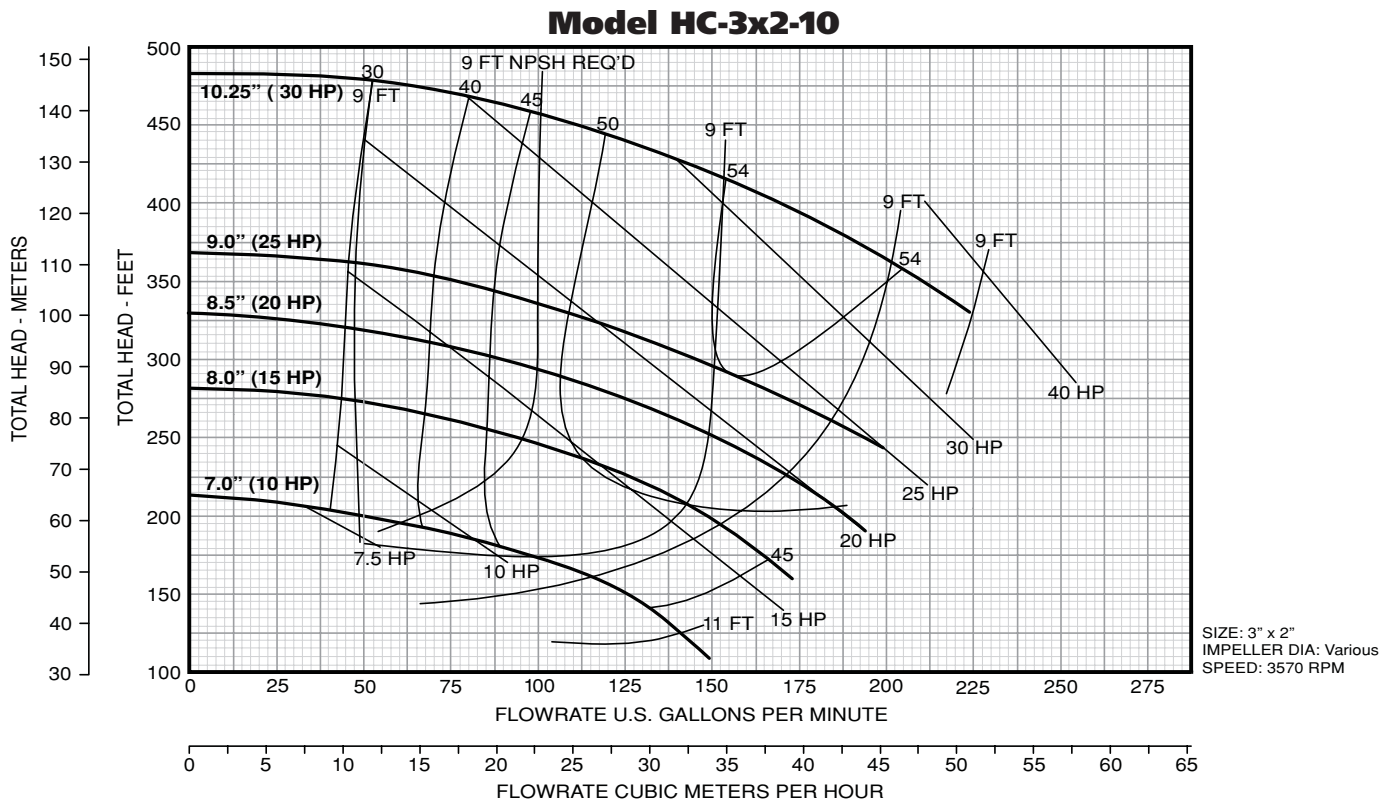

## HC Series

### Standard Centrifugal Pumps- Close Coupled

PAGE: CP-730

DATE: June 5, 2006

#### Model HC-4x25-10

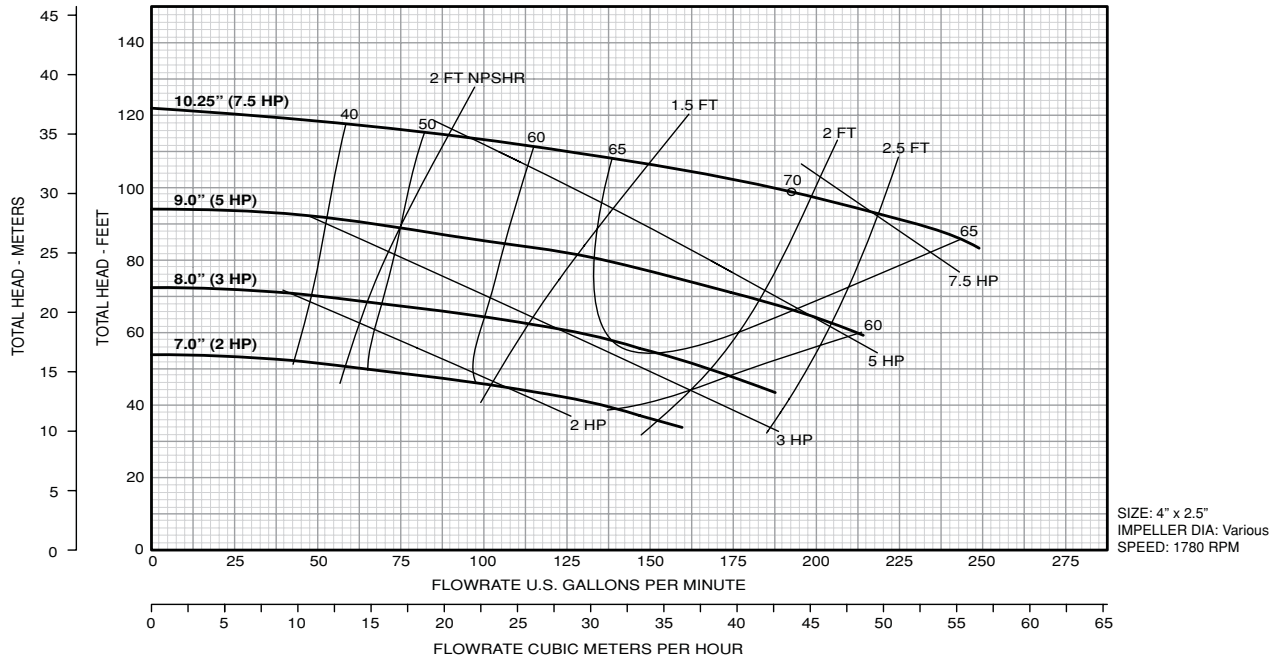

#### Model HC-4x25-10

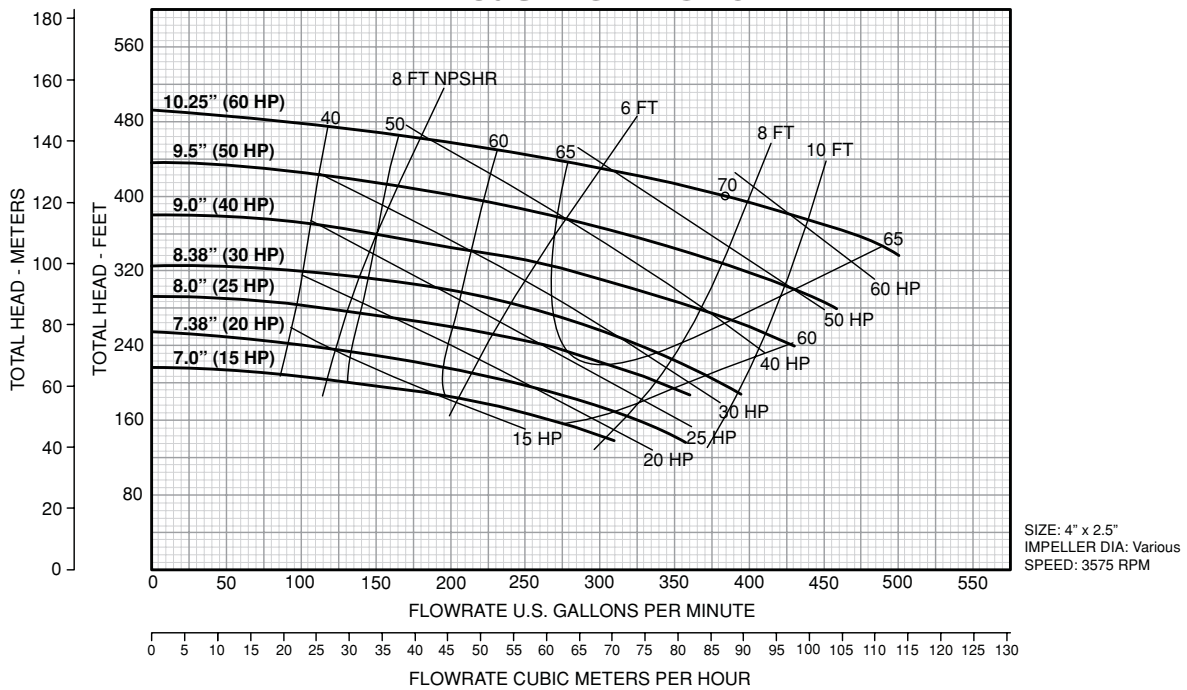



## HC Series Standard Centrifugal Pumps- Close Coupled

PAGE: CP-735

DATE: June 5, 2006

### Model HC-8x6-95

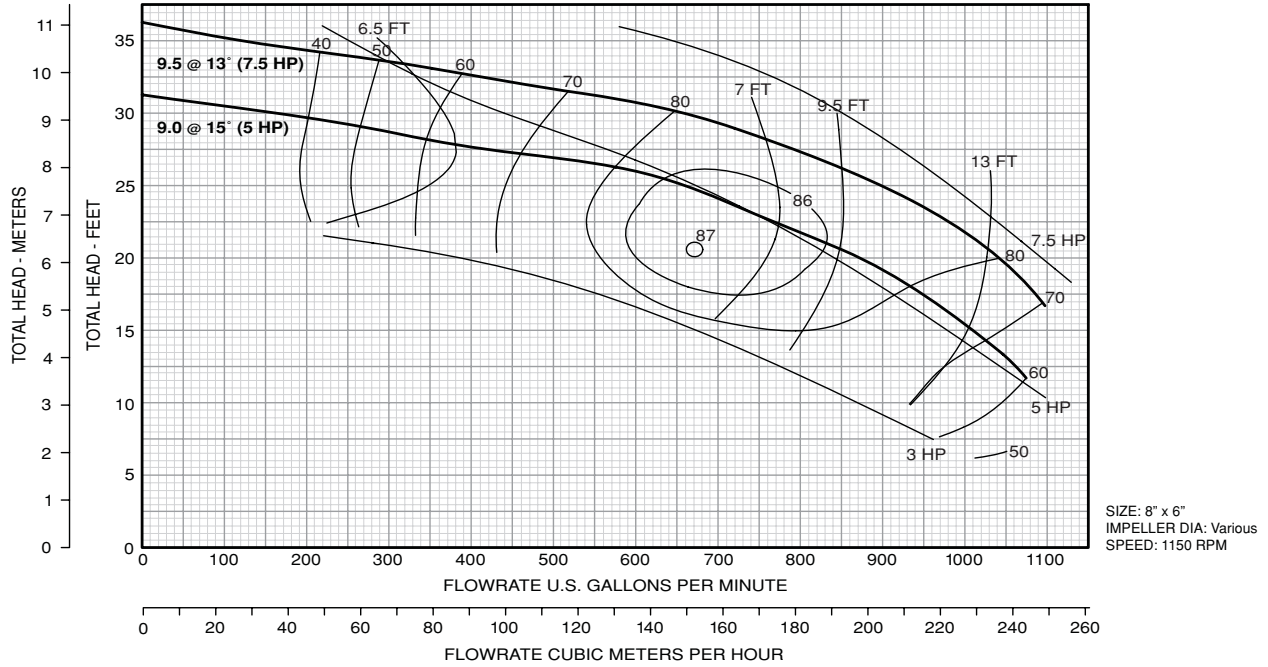

### Model HC-8x6-95

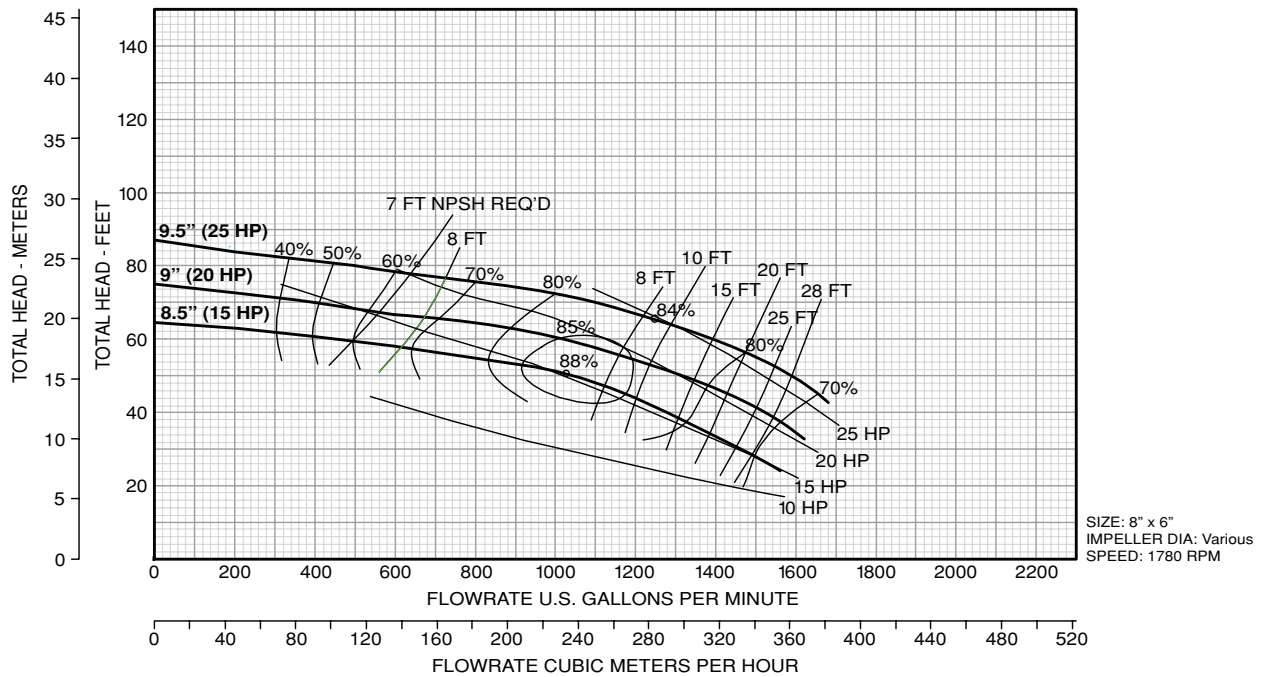

## HC Series

### Standard Centrifugal Pumps- Close Coupled

#### Model HC-8x6-10

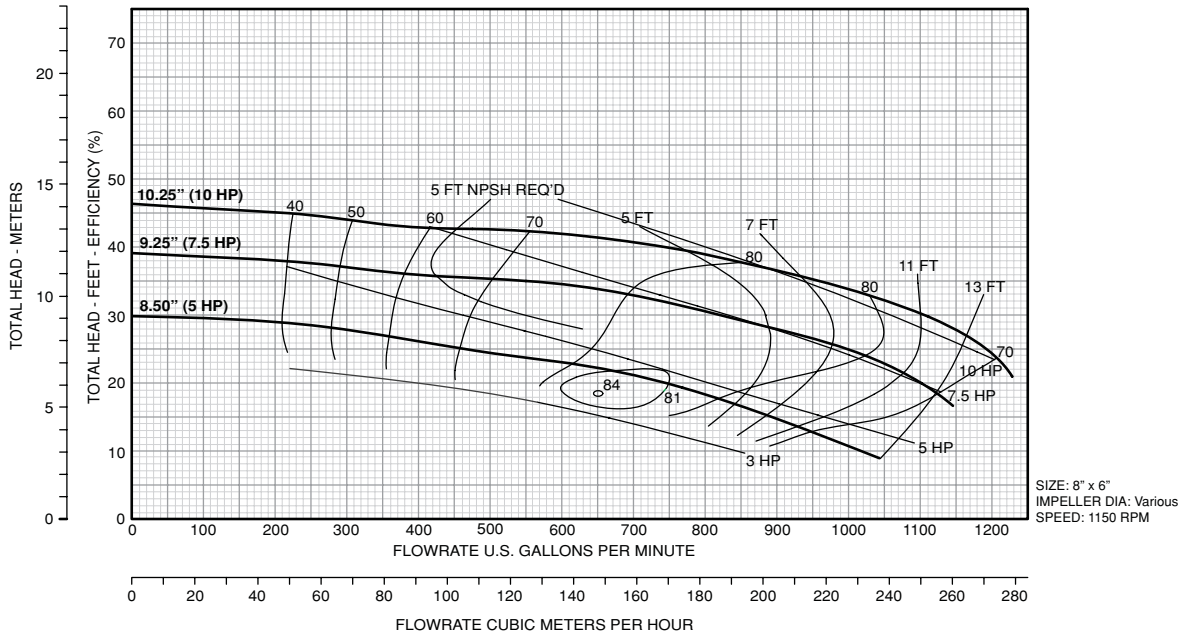

#### Model HC-8x6-10

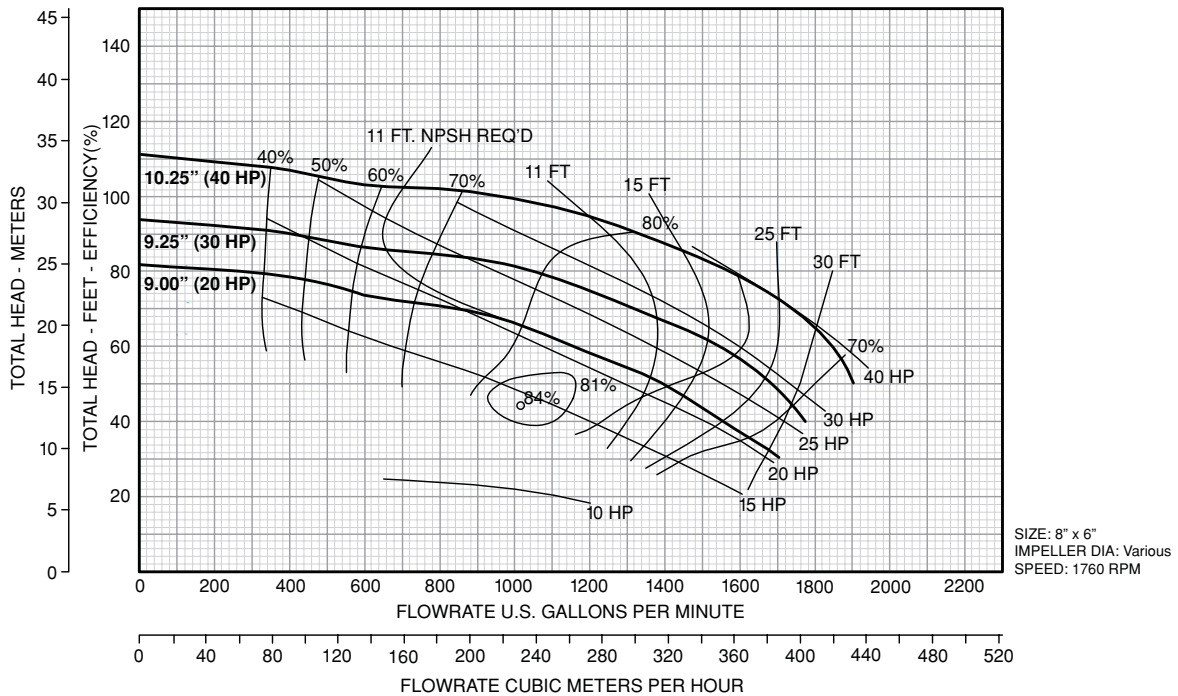

## HC Series Standard Centrifugal Pumps- Close Coupled

PAGE: CP-740  
DATE: June 5, 2006

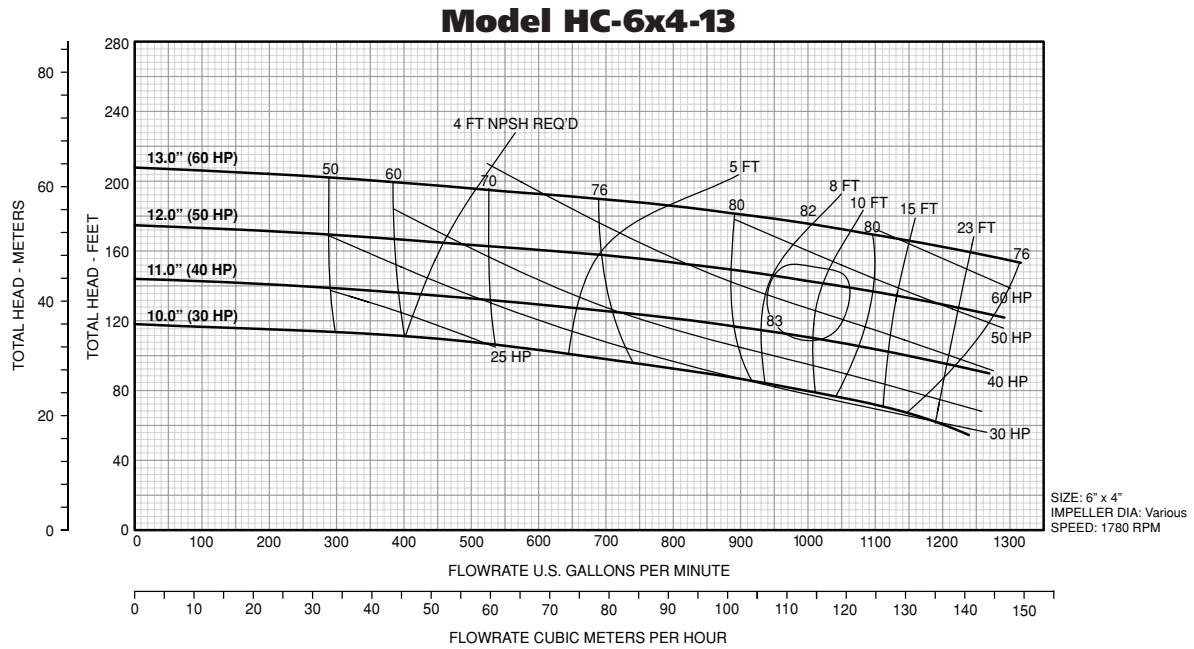
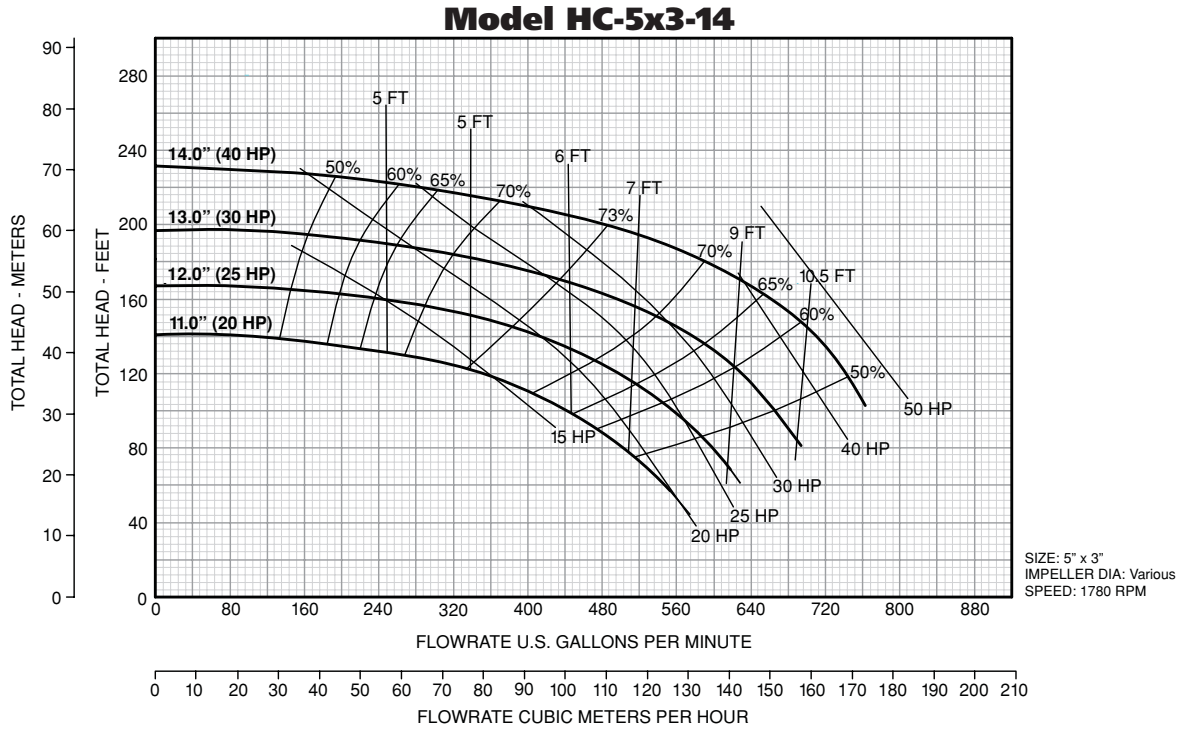

## HC Series

### Standard Centrifugal Pumps- Close Coupled

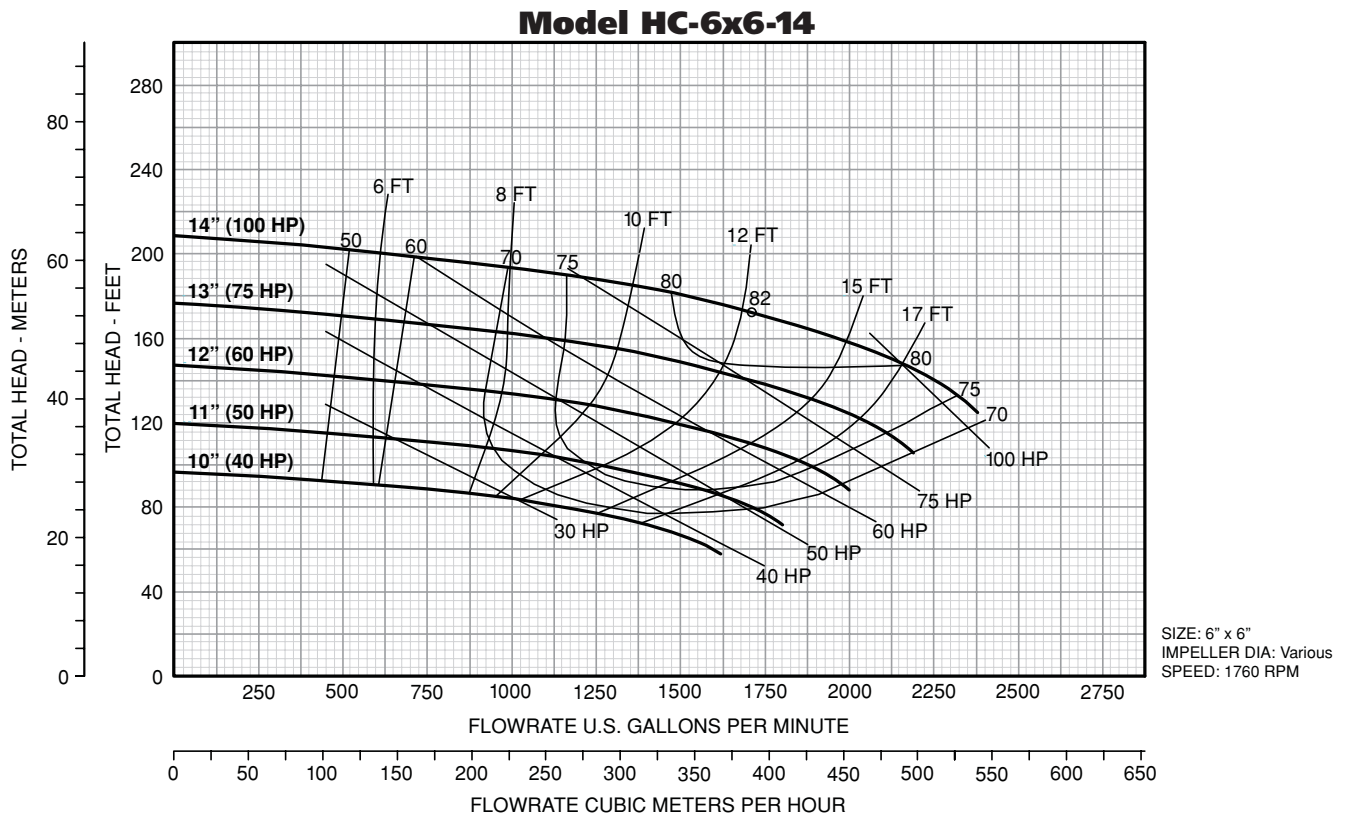

## HC Series Standard Centrifugal Pumps- Close Coupled

PAGE: CP-745

DATE: June 5, 2006

### Model HC-8x6-14

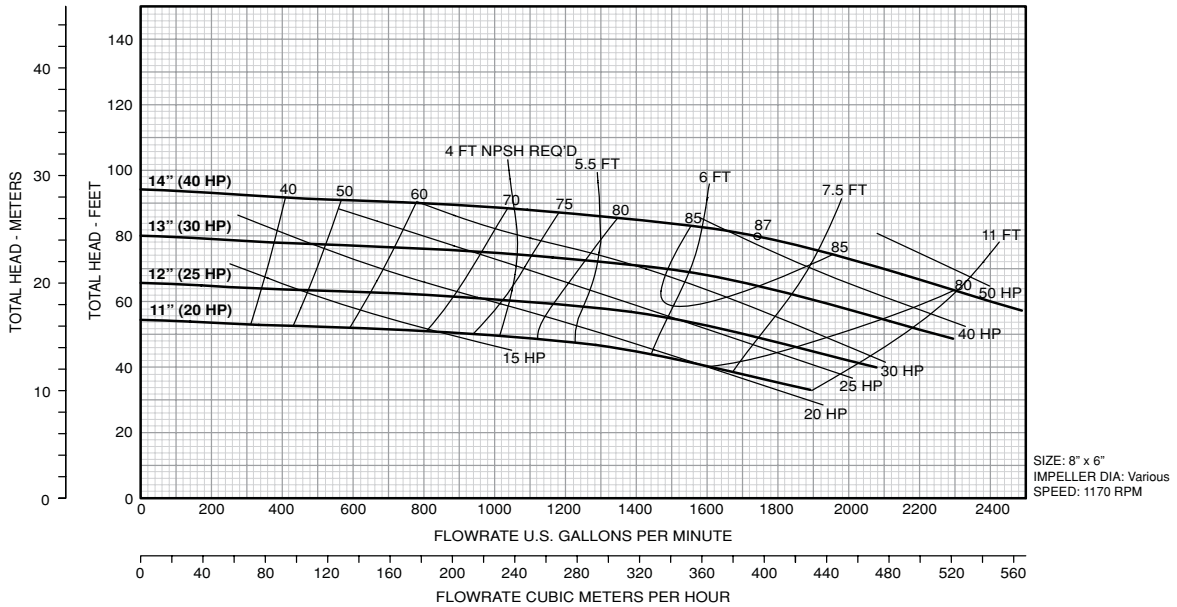

### Model HC-8x6-14

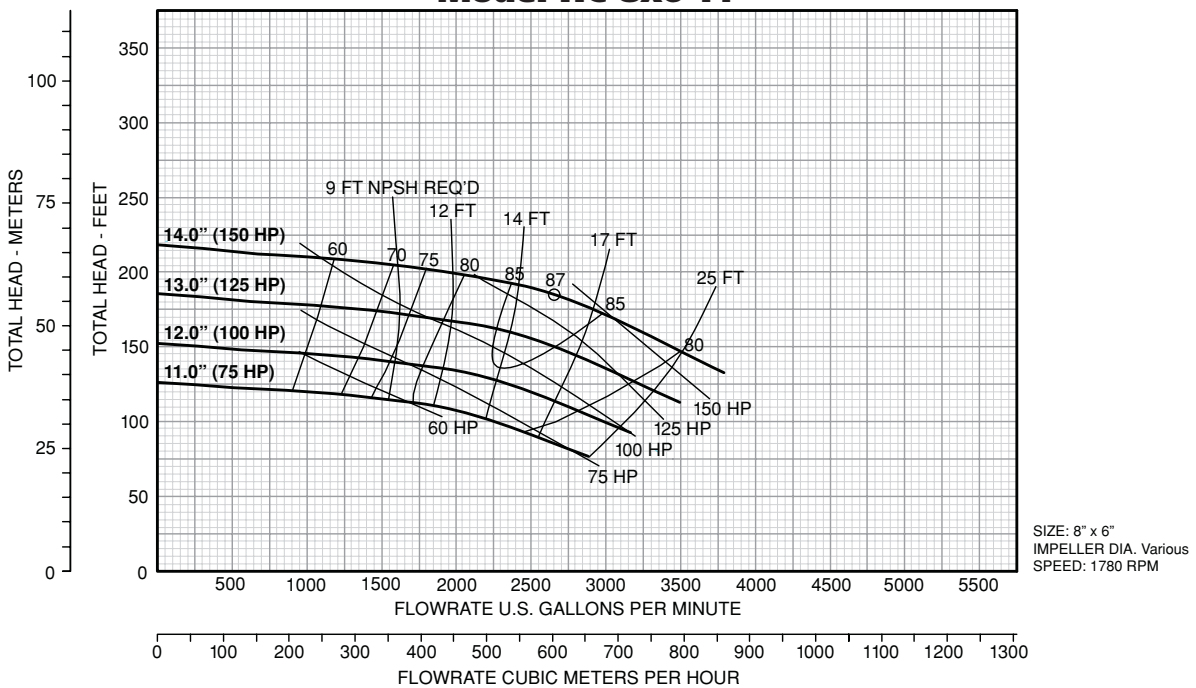

## HC Series

### Standard Centrifugal Pumps- Close Coupled

#### Model HC-10x10-14

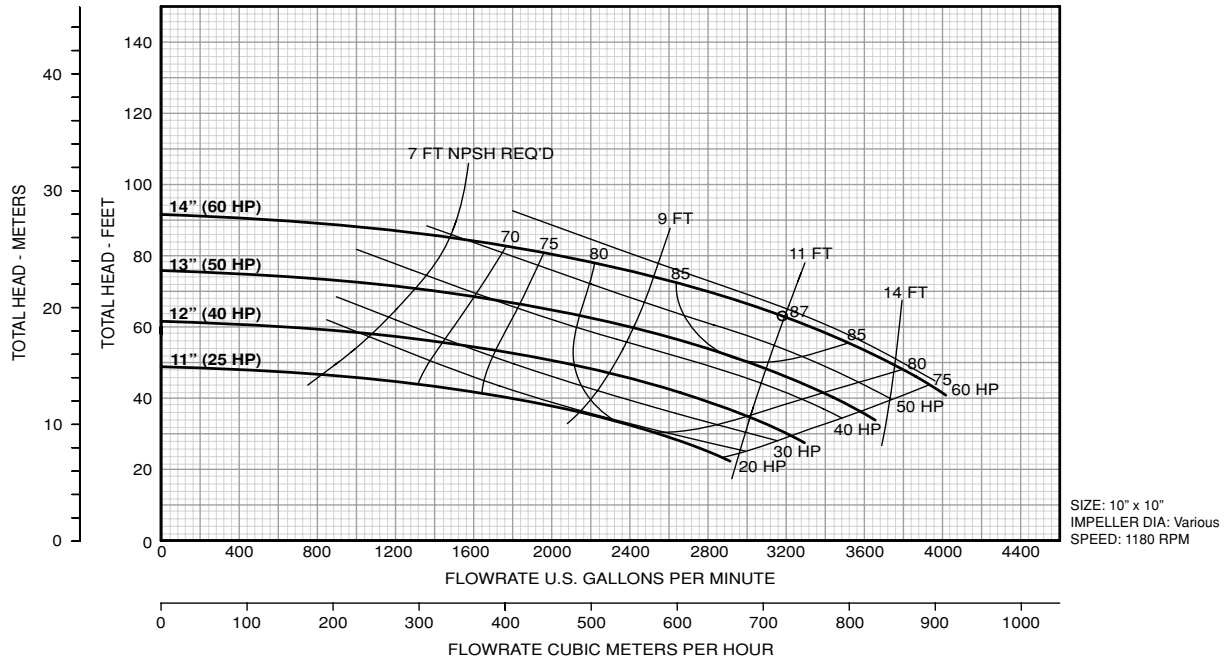

#### Model HC-10x10-14

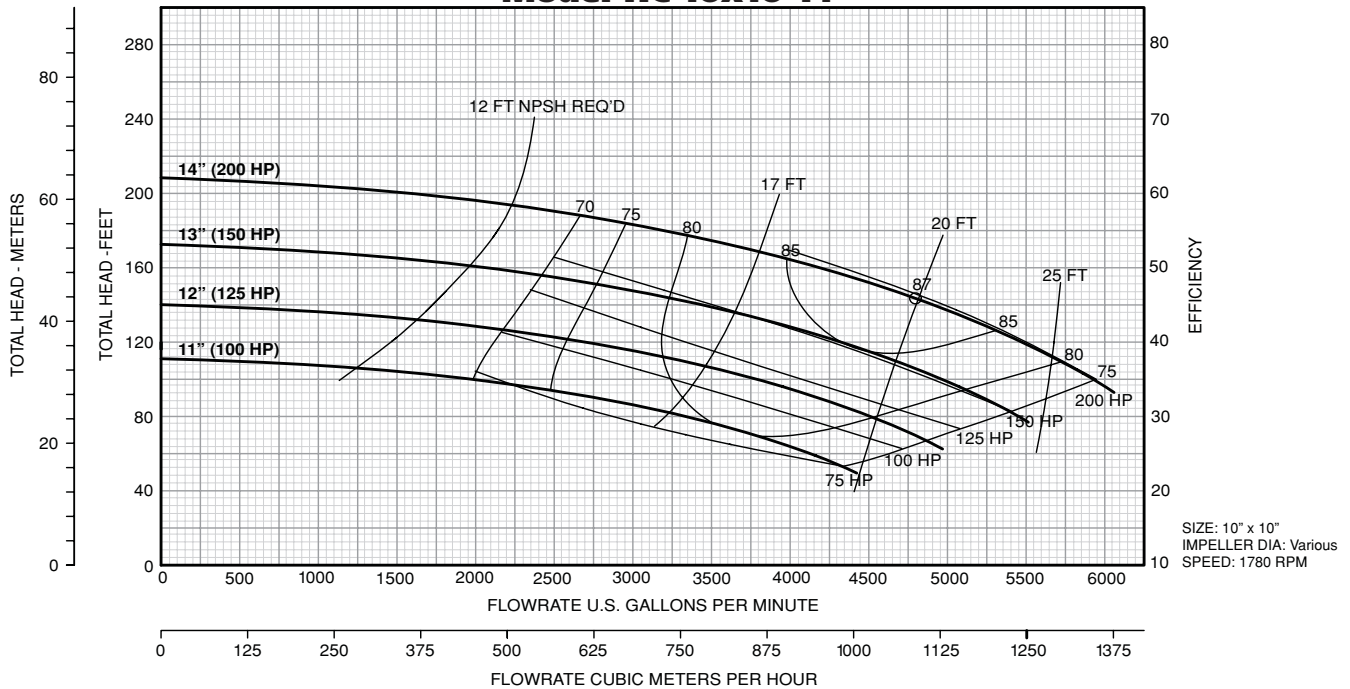

**Franklin Electric**

400 East Spring Street, Bluffton, IN 46714

Tel: 260.824.2900 Fax: 260.824.2909

www.franklinpumps.com